

## APPROVAL SHEET

MODELNO: COG-T350KFY-01PApproval option:  Specification Sample

## ■ Customer' s Confirmation

<b>Customer :</b>
<b>Approved by:</b>
<b>Date:</b>
<b>Note:</b>

## ■ Center Confirmed:

Approved	Checked by	Made by



## Contents

1	Introduction-----	4
2	General specification-----	5
3	Mechanical drawing-----	6
4	Absolute maximum ratings-----	7
5	Electrical characteristics-----	7
6	Optical characteristics -----	8
7	Pin Assignment -----	11
8	Block diagram -----	12
9	Timing/Characteristics-----	13
10	LCM reliability-----	14
11	LCM quality -----	16
12	Packing method-----	23

## 1. Introduction

### 1.1 Scope of application

This specification applies to the Negative type TFT transmissive dot matrix LCD module.

LCD specification: Dots 320xRGBx240.

As to basic specification of the driver IC, refer to the IC (NV3035GTC ) specification and data sheet.

### 1.2 Structure:

Double display structure:

TFT Module + FPC +BL+TP

FULL 16.7M Color3.5 inch TFT LCD size for main LCD;

One bare chip with gold bump (COG) TECH;

24 BITS RGB interface;

### 1.3 TFT features:

Structure: TFT PANNEL+IC+FPC+BL;

Transmissive Type LCD

320 dot-source and 240 dot-gate outputs;

16.7 M Color

White LED back light;

24 BITS RGB interface;

### 1.4 Applications:

Mobile phone

·PSP

PDA

GPS

Etc...

## 2. General specification

ITEM	Standard value	UNIT
LCD Type	TFT Transmissive Normal White	---
Driver element	a-Si TFT Active matrix	
Number of Dots	320*(RGB)*240	Dots
Pixel Arrangement	RGB Vertical Stripe	
Active Area	52.56 *70.08	mm
Viewing Direction	12 0' clock	
Driver IC	NV3035GTC	
Module Size(W*H*T)	76.90x63.90x3.0	mm
Approx. Weight	TBD	g
Back Light	6-LED WHITE	
System interface	24 BITS RGB interface	

### 3. Mechanical drawing

**PIN DESCRIPTION**

1	LEDK	29	D17
2	LEDK	30	D18
3	LEDA	31	D19
4	LEDA	32	D20
5	NC	33	D21
6	NC	34	D22
7	NC	35	D23
8	RESET	36	HSYNC
9	SPENA	37	VSYNC
10	SPCK	38	CLK
11	SPDA	39	NC
12	D00	40	NC
13	D01	41	VDD
14	D02	42	VDD
15	D03	43	NC
16	D04	44	NC
17	D05	45	NC
18	D06	46	NC
19	D07	47	NC
20	D08	48	XR
21	D09	49	YD
22	D10	50	XL
23	D11	51	YU
24	D12	52	DEN
25	D13	53	GND
26	D14	54	GND
27	D15		
28	D16		

**NOTES:**

1. OPERATING TEMP: -20°C~70°C
2. STORAGE TEMP: -30°C~80°C
3. DRIVER IC: COG(IC:NV3035GTC)
4. GENERAL TOLERANCE: ±0.2
5. ( )REFERENCE DIMENSION

**Electrical Circuit:**  
LED:1\*6 PCS

**Circuit Diagram**

**Table:**

Display Type	FTT, 16, 7M
Viewing Angle	TRANSMISSIVE NORMALLY WHITE
LCD Driver IC	12 o'clock
Operating Voltage	W3035GTC
Operation Temperature	VDD=3.3V
Storage Temperature	-20° C TO 70° C
Lumin/Dmax	-30° C TO 80° C
Backlight	80% / 85%
Surface Luminance	19, 2V/20MA
White X/Y	250cd/m2
	p.310±0.05/0.33±0.05

**Table:**

DRAWN	
ME.CHECKED	
EE.CHECKED	
APPROVED	
CUSTOMER'S APPROVAL	

**Table:**

UNIT	mm	SCALE	1:1
SHEET			1 OF 1

**Table:**

VER	SYMBOL	SIGN	DATE
-----	--------	------	------

**Table:**

DRAWING NO.		MODULE SPEC.	
-------------	--	--------------	--

## 4. ABSOLUTE MAXIMUM RATINGS

Parameter	Symbol	Min	Max	Unit
Supply voltage for logic	$V_{DD}$	-0.3	4.0	V
Input voltage for logic	$V_{IN}$	-0.5	$V_{DD} + 0.3$	V
Supply current (One LED)	$I_{LED}$		30	mA
Operating temperature	$T_{OP}$	-20	+70	°C
Storage temperature	$T_{ST}$	-30	+80	°C

## 5. ELECTRICAL CHARACTERISTICS

Item	Symbol	Min	Typ	Max	Unit	Applicable terminal
Supply voltage for logic	$V_{DD}$	3.0	3.3	3.6	V	$V_{DD}$
Input voltage	$V_{IL}$	-0.3	-	$0.3V_{DD}$	V	
	$V_{IH}$	$0.8 V_{DD}$	-	$V_{DD}$	V	
Input current	$I_{DD}$	-	10	-	mA	
LED Forward voltage	$V_f$	3.0	3.2	3.4	V	With one LED
Input backlight current	$I_{LED}$	-	20	25	mA	With One LED

## BACKLIGHT DRIVING CONDITIONS

Item	Symbol	Values			Unit	Remark
		Min.	Typ.	Max.		
Voltage for LED backlight	$V_L$	18	19.2	20.4	V	Note 1
Current for LED backlight	$I_L$	--	20	25	mA	
LED life time	-	20,000	-	-	Hr	Note 2

## 6. OPTICAL CHARACTERISTICS

ITEM	SYMBOL	CONDITIONS	SPECIFICATIONS			UNIT	NOTE
			MIN.	TYP.	MAX		
Brightness	B		270	300	—	Cd/m <sup>2</sup>	All left side data are based on TIANMA's product reference only
Contrast Ratio	CR		400	500	—	—	
Response Time	Tr+Tf		—	25	30	ms	
Chromaticity Coordinate (Transmissive)	Red	X	0.551	0.591	0.631	Viewing normal angle $\theta_x = \theta_y = 0^\circ$ BL Brightness = 4000 Cd/m <sup>2</sup>	
		Y	0.270	0.310	0.350		
	Green	X	0.302	0.342	0.382		
		Y	0.516	0.561	0.601		
	Blue	X	0.105	0.145	0.185		
		Y	0.047	0.087	0.127		
White	X	0.260	0.310	0.360			
	Y	0.283	0.333	0.383			
Viewing Angle	Hor.	$\theta_{x+}$	60	70	—	Center CR>=10	Deg.
		$\theta_{x-}$	60	70	—		
	Ver.	$\theta_{y+}$	40	50	—		
		$\theta_{y-}$	60	70	—		
Uniformity	Un		75	80		%	

Note 1 : Definition of Viewing Angle  $\theta_x$  and  $\theta_y$  :

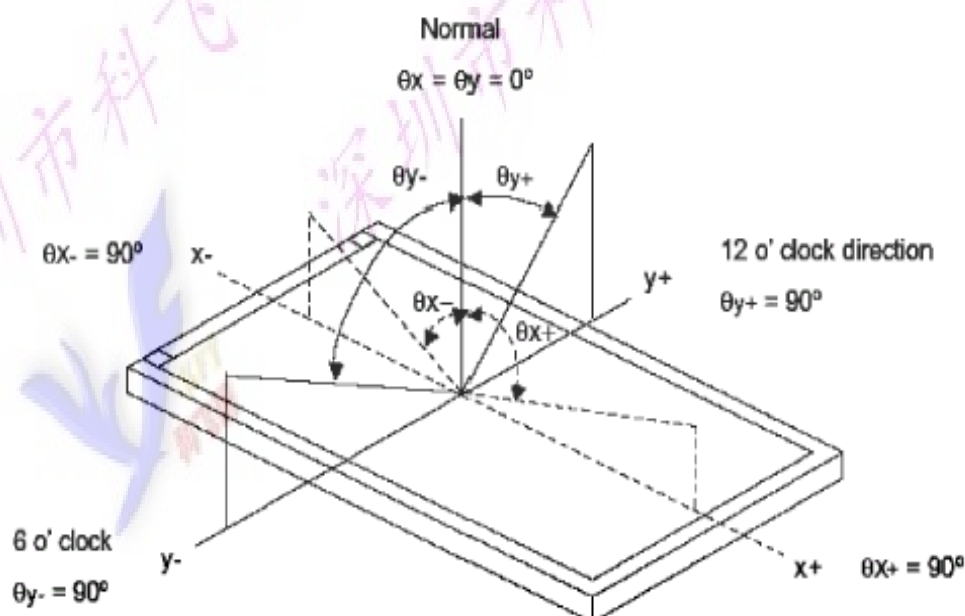



Note 2: Definition of contrast ratio CR:

$$CR = \frac{\text{Brightness of non-selected dots (white)}}{\text{Brightness of selected dots (black)}}$$

Note 3: Definition of response time ( $T_R$ ,  $T_F$ )

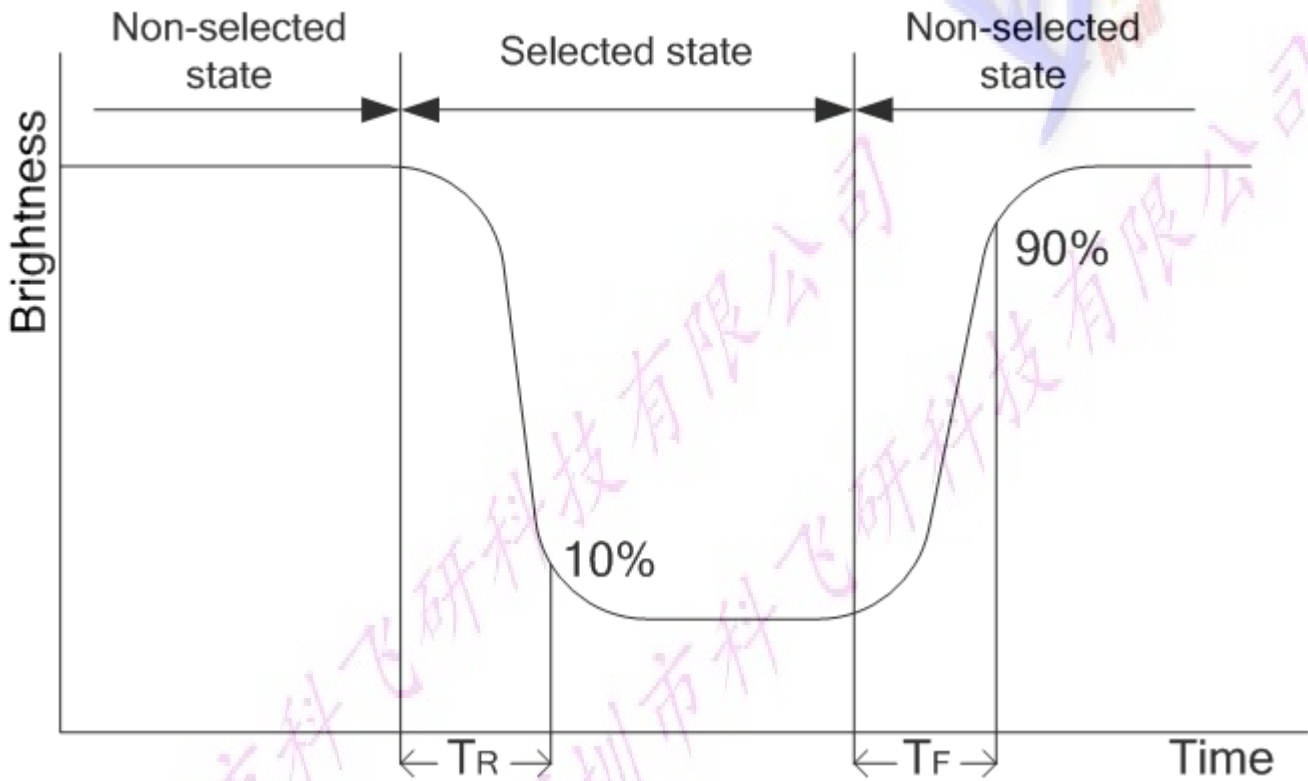

**The brightness test equipment setup**

20mA Field=2° (As measuring "black" image, field=2° is the best testing condition)

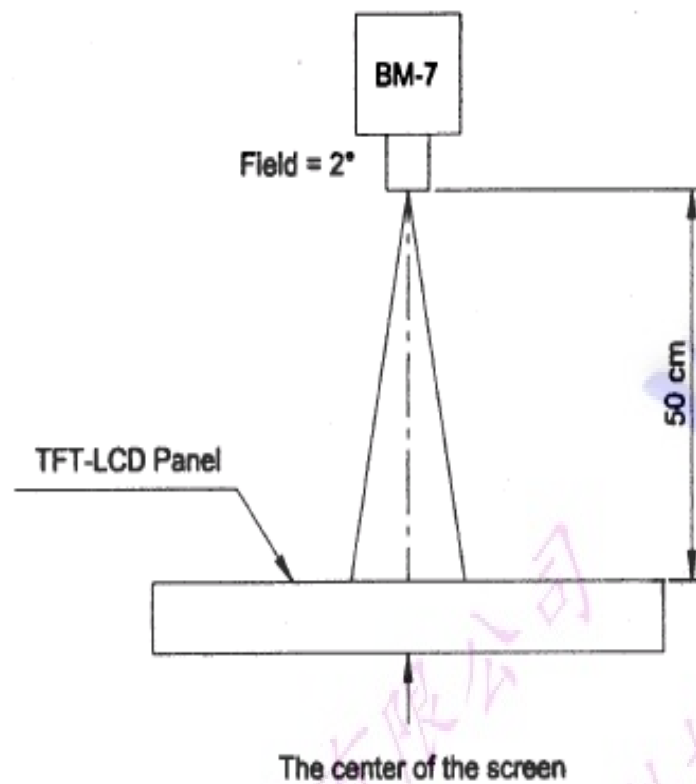

Note 4 :

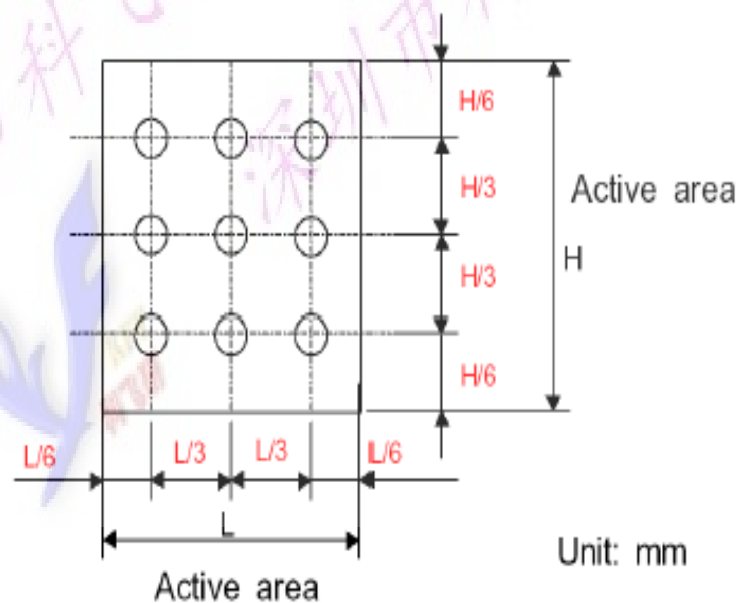

## 7. Interface Pin Function

. Table 2: Pin assignment

Pin No.	Symbol	Description
1	VLED-	Cathode of LED backlight
2	VLED-	Cathode of LED backlight
3	VLED+	Anode of LED backlight
4	VLED+	Anode of LED backlight
5	NC	No connect
6	NC	No connect
7	NC	No connect
8	RESET	Reset pin
9	SPENA	Serial transmissive enable
10	SPCK	Serial clock
11	SPDA	Serial data input
12	D00	Data bus
13	D01	Data bus
14	D02	Data bus
15	D03	Data bus
16	D04	Data bus
17	D05	Data bus
18	D06	Data bus
19	D07	Data bus
20	D08	Data bus
21	D09	Data bus
22	D10	Data bus
23	D11	Data bus
24	D12	Data bus
25	D13	Data bus
26	D14	Data bus
27	D15	Data bus
28	D16	Data bus
29	D17	Data bus
30	D18	Data bus
31	D19	Data bus
32	D20	Data bus
33	D21	Data bus
34	D22	Data bus
35	D23	Data bus
36	HSYNC	Horizontal sync signal
37	VSYNC	Vertical sync signal
38	CLK	Pixel clock
39	NC	NO connect
40	NC	NO connect

41	VDD	Power supply
42	VDD	Power supply
43	NC	No connect
44	NC	No connect
45	NC	No connect
46	NC	No connect
47	NC	No connect
48	XR	TP PIN
49	YU	TP PIN
50	XL	TP PIN
51	YD	TP PIN
52	DEN	TP PIN
53	GND	Ground
54	GND	Ground

深圳市科飞研科技有限公司



## 8. BLOCK DIAGRAM

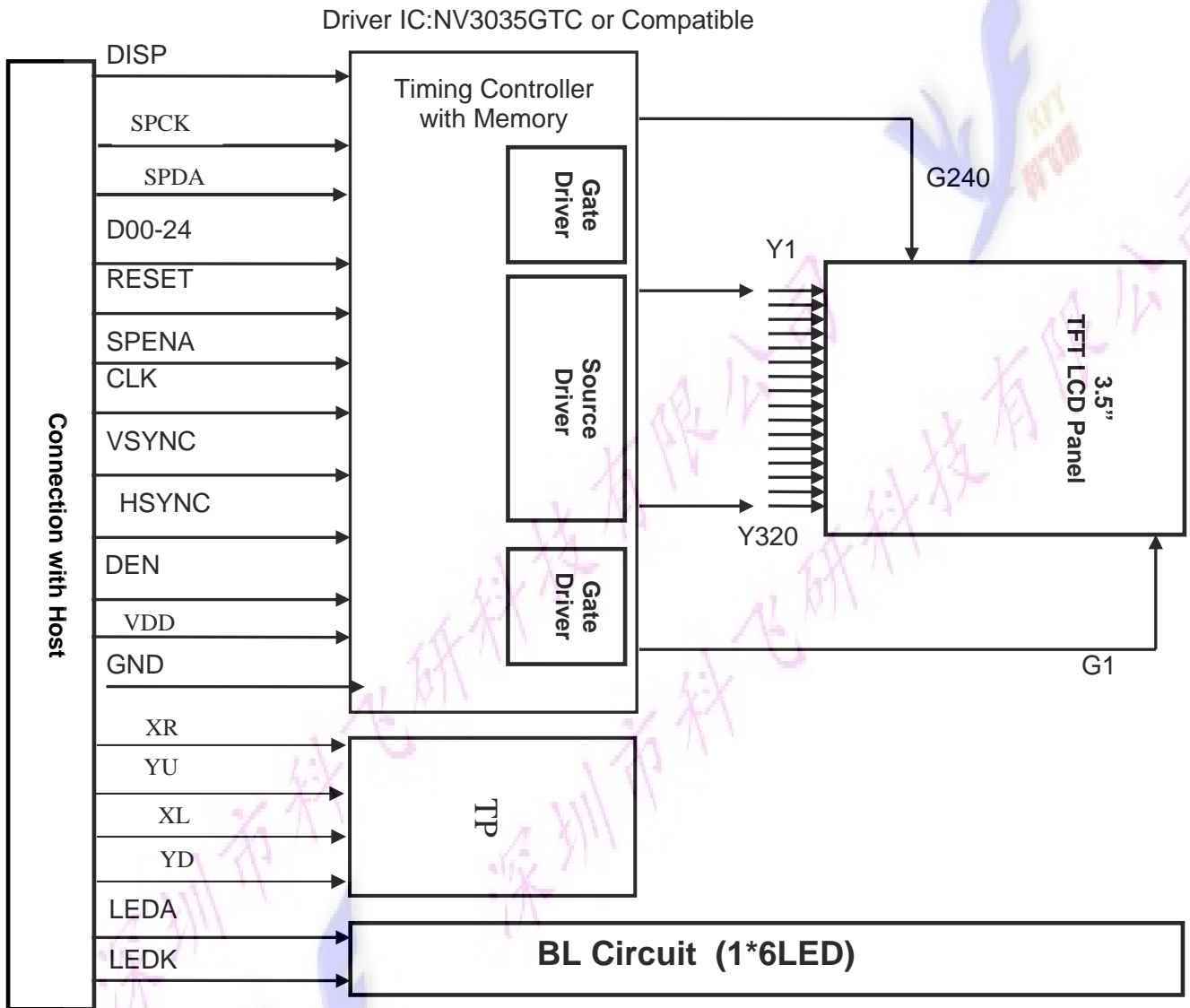

## 9. Timing/Characteristics

### 9.1 Clock and data input time diagram

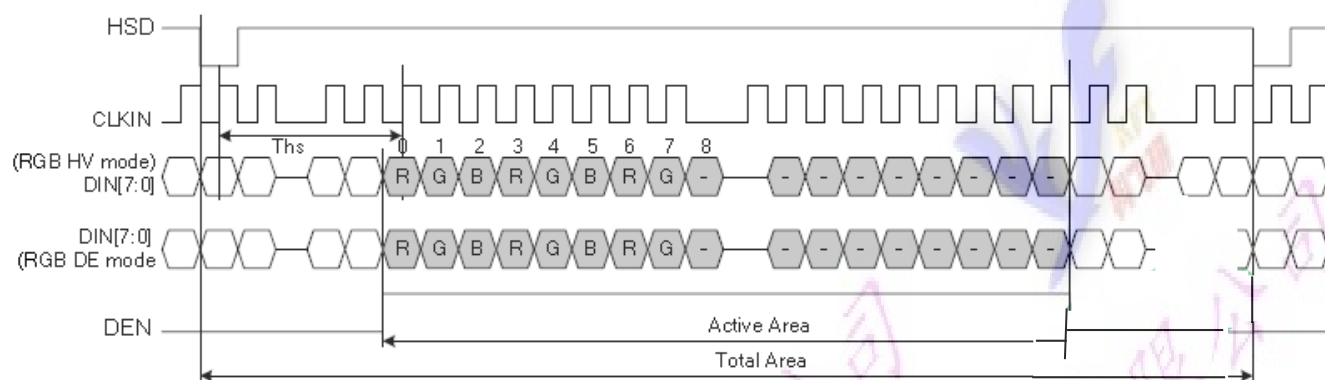

### 9.2 Parallel RGB input timing table

Parameter	Symbol	Min.	Typ.	Max.	Unit	Conditions
CLKIN frequency	Fclk	6.1	6.4	8	MHz	VDD=3.0~3.6V
CLKIN cycle time	Tclk	125	156	164	ns	
CLKIN pulse duty	Tcwh	40	50	60	%	Tclk
Time that HSD to 1st data input (NTSC)	Ths	40	70	255	CLKIN	DDL=70, Offset=0 (fixed)

## 10. Standard Specification for Reliability :

### 10-1. Standard Specifications for Reliability of LCD Module

No	Item	Description
01	High temperature operation	The sample should be allowed to stand at 70 °C for 120 hours under driving condition and then returning it to normal temperature condition, and allowing it stand for 2 hours.
02	Low temperature operation	The sample should be allowed to stand at -20 °C for 120 hours under driving condition and then returning it to normal temperature condition, and allowing it stand for 2 hours.
03	High temperature storage	The sample should be allowed to stand at 80 °C for 240 hours under no-load condition, and then returning it to normal temperature condition, and allowing it stand for 2 hours.
04	Low temperature storage	The sample should be allowed to stand at -30 °C for 240 hours under no-load condition, then returning it to normal temperature condition, and allowing it stand for 2 hours.
05	Moisture storage	The sample should be allowed to stand at 60 °C, 90%RH MAX for 240 hours under no-load condition, then taking it out and drying it at normal temperature for 2 hours.
06	Thermal shock storage	The sample should be allowed to stand the following 10 cycles : -30 °C for 30 minutes → normal temperature for 5 minutes → +80 °C for 30 minutes → normal temperature for 5 minutes, as one cycle.
07	Packing vibration	Frequency range : 10Hz ~ 55Hz Amplitude of vibration : 1.5mm Sweep time: 12 min X, Y, Z 2 hours for each direction.
08	Packing drop test	According to ISTA 1A 2001.
09	Electrical Static Discharge	Air: ±4KV 150pF/330 Ω 5 times
		Contact: ±2KV 150pF/330 Ω 5 time

\*Sample size for each test item is 3~5pcs

## 10 - 2. Testing Conditions and Inspection Criteria

For the final test the testing sample must be stored at room temperature for 24 hours, after the tests listed in Table 12.2, Standard specifications for Reliability have been executed in order to ensure stability.

No	Item	Test Model	In section Criteria
01	Current Consumption	Refer To Specification	The current consumption should conform to the product specification.
02	Contrast	Refer To Specification	After the tests have been executed, the contrast must be larger than half of its initial value prior to the tests.
03	Appearance	Visual inspection	Defect free.

## 10- 3. MTBF

MTBF	Functions, performance, appearance, etc. shall be free from remarkable deterioration within 50,000 hours under ordinary operating and storage conditions room temperature ( $25 \pm 5^{\circ}\text{C}$ ), normal humidity ( $50 \pm 10\% \text{RH}$ ), and in area not exposed to direct sun light.
------	---



## 11. Specification of Quality Assurance:

### 11-1. Purpose

This standard for Quality Assurance should affirm the quality of LCD module products to supply to purchaser by TeCenStar.

### 11-2. Standard for Quality Test

#### a. Inspection:

Before delivering, the supplier should take the following tests, and affirm the quality of product.

#### b. Electro-Optical Characteristics:

According to the individual specification to test the product.

#### c. Test of Appearance Characteristics:

According to the individual specification to test the product.

#### d. Test of Reliability Characteristics:

According to the definition of reliability on the specification for testing products.

#### e. Delivery Test:

Before delivering, the supplier should take the delivery test.

(i) Test method: According to MIL-STD105E. General Inspection Level II take a single time.

(ii) The defects classify of AQL as following:

Major defect: AQL = 0.65

Minor defect: AQL = 2.5

Total defects: AQL = 2.5

### 11-3. Non-conforming Analysis & Deal With Manners

#### a. Non-conforming Analysis:

(i) Purchaser should supply the detail data of non-conforming sample and the non-conforming.

(ii) After accepting the detail data from purchaser, the analysis of non-conforming should be finished in two weeks.

(iii) If supplier can not finish analysis on time, must announce purchaser before 3 days.

#### b. Disposition of non-conforming:

(i) If find any product defect of supplier during assembly time, supplier must change the good product for every defect after recognition.

(ii) Both supplier and customer should analyze the reason and discuss the disposition of non-conforming when the reason of nonconforming is not sure.

### 11-4. Agreement items

Both sides should discuss together when the following problems happen.

a. There is any problem of standard of quality assurance, and both sides should think that must be modified.

b. There is any argument item which does not record in the standard of quality assurance.

c. Any other special problem.

## 11-5. Standard of The Product Appearance Test

## a. Manner of appearance test:

(i) The test must be under 20W × 2 or 40W fluorescent light, and the distance of view must be at  $30 \pm 5$ cm.

(ii) When test the model of transmissive product must add the reflective plate.

(iii) The test direction is base on around  $10^\circ$  of vertical line.

(iiii) Temperature:  $25 \pm 5^\circ\text{C}$  Humidity:  $60 \pm 10\% \text{RH}$

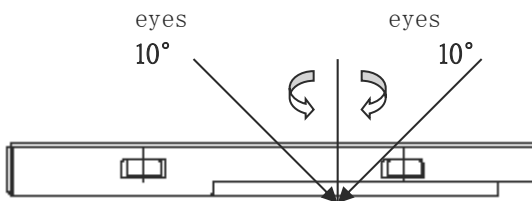

## (iv) Definition of area:



A. Area: Viewing area.

B. Area: Out of viewing area.

(Outside viewing area)

## b. Basic principle:

(i) It will accord to the AQL when the standard can not be described.

(ii) The sample of the lowest acceptable quality level must be discussed by both supplier and customer when any dispute happened.

(iii) Must add new item on time when it is necessary.

## c. Standard of inspection: (Unit: mm)

11-6. Inspection specification

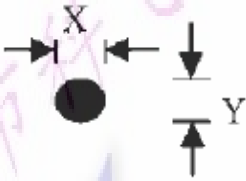
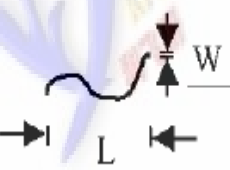
NO	Item	Criterion	AQL												
01	Electrical Testing	1.1 Missing vertical, horizontal segment, segment contrast defect. 1.2 Missing character, dot or icon. 1.3 Display malfunction. 1.4 No function or no display. 1.5 Current consumption exceeds product specifications. 1.6 LCD viewing angle defect. 1.7 Mixed product types. 1.8 Flicker	0.65												
02	Black or White spots or Bright spots or Color spots on LCD (Display only)	2.1 White and black or color spots on display $\leq 0.25\text{mm}$ , no more than Five spots. 2.2 Densely spaced: No more than three spots within 3mm.	2.5												
03	LCD and Touch Panel black spots, white spots, contamination (non - display)	3.1 Round type: As following drawing $\Phi = (X+Y) / 2$  <table border="1" data-bbox="753 1102 1286 1319"> <thead> <tr> <th>Size (mm)</th> <th>Acceptable Q' ty</th> </tr> </thead> <tbody> <tr> <td><math>\Phi \leq 0.10</math></td> <td>Accept no dense</td> </tr> <tr> <td><math>0.10 &lt; \Phi \leq 0.20</math></td> <td>2</td> </tr> <tr> <td><math>0.20 &lt; \Phi \leq 0.25</math></td> <td>2</td> </tr> <tr> <td><math>0.25 &lt; \Phi \leq 0.30</math></td> <td>1</td> </tr> <tr> <td><math>0.30 &lt; \Phi</math></td> <td>0</td> </tr> </tbody> </table> <p style="text-align: center;">* Densely spaced: No more than two spots within 3mm.</p>	Size (mm)	Acceptable Q' ty	$\Phi \leq 0.10$	Accept no dense	$0.10 < \Phi \leq 0.20$	2	$0.20 < \Phi \leq 0.25$	2	$0.25 < \Phi \leq 0.30$	1	$0.30 < \Phi$	0	2.5
		Size (mm)	Acceptable Q' ty												
$\Phi \leq 0.10$	Accept no dense														
$0.10 < \Phi \leq 0.20$	2														
$0.20 < \Phi \leq 0.25$	2														
$0.25 < \Phi \leq 0.30$	1														
$0.30 < \Phi$	0														
3.2 Line type: (As following drawing)  <table border="1" data-bbox="657 1453 1286 1671"> <thead> <tr> <th>Length(m)</th> <th>Width(mm)</th> <th>Acceptable Q' ty</th> </tr> </thead> <tbody> <tr> <td>---</td> <td><math>W \leq 0.02</math></td> <td>Accept no dense</td> </tr> <tr> <td><math>L \leq 3.0</math></td> <td><math>0.02 &lt; W \leq 0.05</math></td> <td rowspan="2">2</td> </tr> <tr> <td><math>L \leq 2.5</math></td> <td><math>0.03 &lt; W \leq 0.08</math></td> </tr> <tr> <td>---</td> <td><math>0.08 &lt; W</math></td> <td>Rejection</td> </tr> </tbody> </table> <p style="text-align: center;">* Densely spaced: No more than two lines within 3mm.</p>	Length(m)	Width(mm)	Acceptable Q' ty	---	$W \leq 0.02$	Accept no dense	$L \leq 3.0$	$0.02 < W \leq 0.05$	2	$L \leq 2.5$	$0.03 < W \leq 0.08$	---	$0.08 < W$	Rejection	2.5
Length(m)	Width(mm)	Acceptable Q' ty													
---	$W \leq 0.02$	Accept no dense													
$L \leq 3.0$	$0.02 < W \leq 0.05$	2													
$L \leq 2.5$	$0.03 < W \leq 0.08$														
---	$0.08 < W$	Rejection													

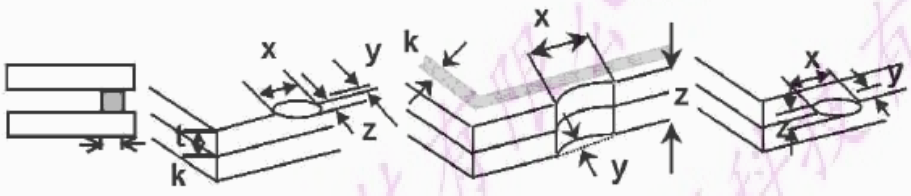
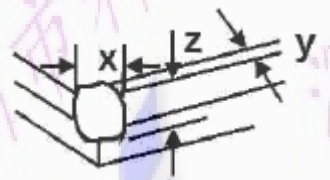
NO	Item	Criterion	AQL																		
04	Polarize r bubbles	If bubbles are visible, judge using black spot specifications, not easy to find, must check in specify direction <table border="1" data-bbox="826 309 1321 526" style="margin-left: auto; margin-right: auto;"> <thead> <tr> <th>Size <math>\Phi</math> (mm)</th> <th>Acceptable Q' ty</th> </tr> </thead> <tbody> <tr> <td><math>\Phi \leq 0.20</math></td> <td>Accept no dense</td> </tr> <tr> <td><math>0.20 &lt; \Phi \leq 0.50</math></td> <td>3</td> </tr> <tr> <td><math>0.50 &lt; \Phi \leq 1.00</math></td> <td>2</td> </tr> <tr> <td><math>1.00 &lt; \Phi</math></td> <td>0</td> </tr> <tr> <td>Total Q' ty</td> <td>3</td> </tr> </tbody> </table>	Size $\Phi$ (mm)	Acceptable Q' ty	$\Phi \leq 0.20$	Accept no dense	$0.20 < \Phi \leq 0.50$	3	$0.50 < \Phi \leq 1.00$	2	$1.00 < \Phi$	0	Total Q' ty	3	2.5						
Size $\Phi$ (mm)	Acceptable Q' ty																				
$\Phi \leq 0.20$	Accept no dense																				
$0.20 < \Phi \leq 0.50$	3																				
$0.50 < \Phi \leq 1.00$	2																				
$1.00 < \Phi$	0																				
Total Q' ty	3																				
05	Scratche s	Follow NO.3 -2 Line Type.																			
06	Chipped glass	<p>Symbols:                      x: Chip length      y: Chip width      z: Chip thickness                      k: Seal width      t: Glass thickness      a: LCD side length                      L: Electrode pad length</p> <p>6.1 General glass chip:                      6.1.1 Chip on panel surface and crack between panels:</p>  <table border="1" data-bbox="336 1025 1155 1137" style="margin-left: auto; margin-right: auto;"> <thead> <tr> <th>z: Chip thickness</th> <th>y: Chip width</th> <th>x: Chip length</th> </tr> </thead> <tbody> <tr> <td><math>Z \leq 1/2t</math></td> <td>Not over viewing area</td> <td><math>x \leq 1/8a</math></td> </tr> <tr> <td><math>1/2t &lt; z \leq 2t</math></td> <td>Not exceed 1/3k</td> <td><math>x \leq 1/8a</math></td> </tr> </tbody> </table> <p>⊙ Unit: mm                      ⊙ If there are 2 or more chips, x is the total length of each chip</p> <p>6.1.2 Corner crack:</p>  <table border="1" data-bbox="336 1518 1155 1630" style="margin-left: auto; margin-right: auto;"> <thead> <tr> <th>z: Chip thickness</th> <th>y: Chip width</th> <th>x: Chip length</th> </tr> </thead> <tbody> <tr> <td><math>Z \leq 1/2t</math></td> <td>Not over viewing area</td> <td><math>x \leq 1/8a</math></td> </tr> <tr> <td><math>1/2t &lt; z \leq 2t</math></td> <td>Not exceed 1/3k</td> <td><math>x \leq 1/8a</math></td> </tr> </tbody> </table> <p>⊙ Unit: mm                      ⊙ If there are 2 or more chips, x is the total length of each chip</p>	z: Chip thickness	y: Chip width	x: Chip length	$Z \leq 1/2t$	Not over viewing area	$x \leq 1/8a$	$1/2t < z \leq 2t$	Not exceed 1/3k	$x \leq 1/8a$	z: Chip thickness	y: Chip width	x: Chip length	$Z \leq 1/2t$	Not over viewing area	$x \leq 1/8a$	$1/2t < z \leq 2t$	Not exceed 1/3k	$x \leq 1/8a$	2.5
z: Chip thickness	y: Chip width	x: Chip length																			
$Z \leq 1/2t$	Not over viewing area	$x \leq 1/8a$																			
$1/2t < z \leq 2t$	Not exceed 1/3k	$x \leq 1/8a$																			
z: Chip thickness	y: Chip width	x: Chip length																			
$Z \leq 1/2t$	Not over viewing area	$x \leq 1/8a$																			
$1/2t < z \leq 2t$	Not exceed 1/3k	$x \leq 1/8a$																			

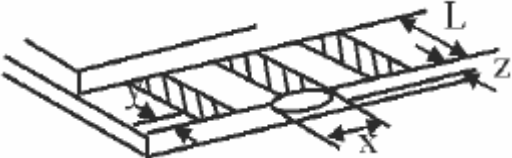
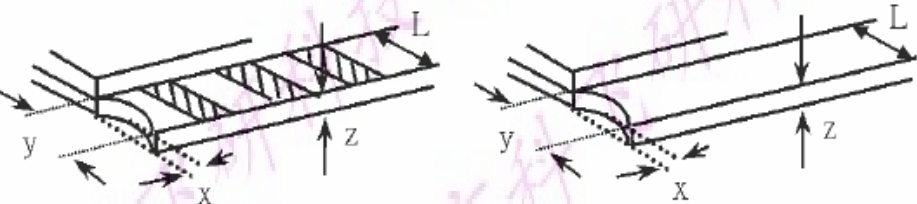
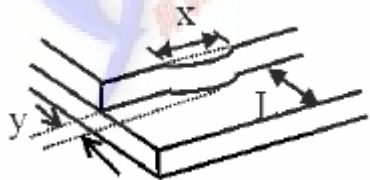
NO	Item	Criterion	AQL																
07	Glass crack	<p>Symbols:                      x: Chip length      y: Chip width      z: Chip thickness                      k: Seal width      t: Glass thickness      a: LCD side length                      L: Electrode pad length</p> <p>7.2 Protrusion over terminal:                      7.2.1 Chip on electrode pad:</p>  <table border="1" data-bbox="497 689 1187 846"> <tr> <td>y: Chip width</td> <td>x: Chip length</td> <td>z: Chip thickness</td> </tr> <tr> <td><math>y \leq 0.5\text{mm}</math></td> <td><math>x \leq 1/8a</math></td> <td><math>0 &lt; z \leq t</math></td> </tr> </table> <p>7.2.2 Non-portion:</p>  <table border="1" data-bbox="497 1187 1187 1344"> <tr> <td>y: Chip width</td> <td>x: Chip length</td> <td>z: Chip thickness</td> </tr> <tr> <td><math>y \leq L</math></td> <td><math>x \leq 1/8a</math></td> <td><math>0 &lt; z \leq t</math></td> </tr> </table> <p>conductive</p> <p>⊙ If there chipped area touches the ITO terminal, over 2/3 of the ITO must remain and be inspected according to electrode terminal specifications.                      ⊙ If the product will be heat sealed by the customer, the alignment mark must not be damaged.</p> <p>7.2.3 Substrate protuberance and internal crack</p>  <table border="1" data-bbox="798 1594 1238 1751"> <tr> <td>y: width</td> <td>x: length</td> </tr> <tr> <td><math>y \leq 1/3L</math></td> <td><math>X \leq a</math></td> </tr> </table>	y: Chip width	x: Chip length	z: Chip thickness	$y \leq 0.5\text{mm}$	$x \leq 1/8a$	$0 < z \leq t$	y: Chip width	x: Chip length	z: Chip thickness	$y \leq L$	$x \leq 1/8a$	$0 < z \leq t$	y: width	x: length	$y \leq 1/3L$	$X \leq a$	2.5
y: Chip width	x: Chip length	z: Chip thickness																	
$y \leq 0.5\text{mm}$	$x \leq 1/8a$	$0 < z \leq t$																	
y: Chip width	x: Chip length	z: Chip thickness																	
$y \leq L$	$x \leq 1/8a$	$0 < z \leq t$																	
y: width	x: length																		
$y \leq 1/3L$	$X \leq a$																		

NO	Item	Criterion	AQL
08	Cracked glass	The LCD with extensive crack is not acceptable.	2.5
09	Backlight elements	9.1 Illumination source flickers when lit. 9.2 Spots or scratches that appear when lit must be judged. Using LCD spot, lines and contamination standards. 9.3 Backlight doesn't light or color is wrong.	2.5 2.5 0.65
10	Bezel	Bezel must comply with product specifications.	2.5
11	PCB、COB	11.1 COB seal may not have pinholes larger than 0.2mm or contamination. 11.2 COB seal surface may not have pinholes through to the IC. 11.3 The height of the COB should not exceed the height indicated in the assembly diagram. 11.4 There may not be more than 2mm of sealant outside the seal area on PCB. And there should be no more than three places. 11.5 Parts on PCB must be the same as on the production characteristic chart, There should be no wrong parts, missing parts or excess parts. 11.6 The jumper on the PCB should conform to the product characteristic chart.	2.5 2.5 2.5 2.5 0.65 0.65
12	FPC	12.1 FPC terminal damage $\leq$ 1/2 FPC terminal width and can not affect the function , we judge accept. 12.2 FPC alignment hole damage $\leq$ 1/2 alignment area and can not affect the function , we judge accept.	2.5 2.5
13	Soldering	13.1 No cold solder joints, missing solder connections, oxidation or icicle. 13.2 No short circuits in components on PCB or FPC.	2.5 0.65

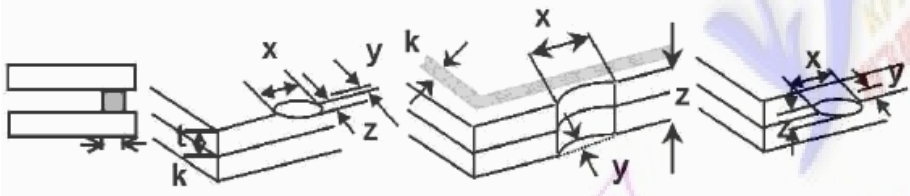
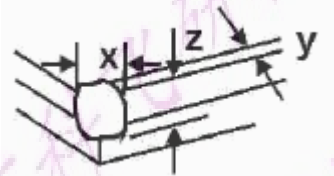
NO	Item	Criterion	AQL												
14	Touch Panel Chipped glass	<p>Symbols:                      x: Chip length      y: Chip width      z: Chip thickness                      k: Seal width      t: Touch Panel Total thickness      a: LCD side length                      L: Electrode pad length</p> <p>14.1 General glass chip:                      14.1.1 Chip on panel surface and crack between panels:</p>  <table border="1" data-bbox="359 766 1179 981"> <tr> <td>z: Chip thickness</td> <td>y: Chip width</td> <td>x: Chip length</td> </tr> <tr> <td><math>Z \leq t</math></td> <td><math>\leq 1/2 k</math> and not over viewing area</td> <td><math>x \leq 1/8a</math></td> </tr> </table> <p>⊙ Unit: mm                      ⊙ If there are 2 or more chips, x is the total length of each chip</p> <p>14.1.2 Corner crack:</p>  <table border="1" data-bbox="359 1328 1179 1543"> <tr> <td>z: Chip thickness</td> <td>y: Chip width</td> <td>x: Chip length</td> </tr> <tr> <td><math>z \leq t</math></td> <td><math>\leq 1/2 k</math> and not over viewing area</td> <td><math>x \leq 1/8a</math></td> </tr> </table> <p>⊙ Unit: mm                      ⊙ If there are 2 or more chips, x is the total length of each chip</p>	z: Chip thickness	y: Chip width	x: Chip length	$Z \leq t$	$\leq 1/2 k$ and not over viewing area	$x \leq 1/8a$	z: Chip thickness	y: Chip width	x: Chip length	$z \leq t$	$\leq 1/2 k$ and not over viewing area	$x \leq 1/8a$	2.5
z: Chip thickness	y: Chip width	x: Chip length													
$Z \leq t$	$\leq 1/2 k$ and not over viewing area	$x \leq 1/8a$													
z: Chip thickness	y: Chip width	x: Chip length													
$z \leq t$	$\leq 1/2 k$ and not over viewing area	$x \leq 1/8a$													

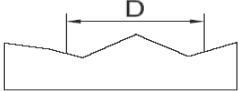
NO	Item	Criterion	AQL										
15	Touch Panel (Fish eye, dent and bubble on film)	<table border="1" data-bbox="395 286 930 472"> <thead> <tr> <th>SIZE (mm)</th> <th>Acceptable Q' ty</th> </tr> </thead> <tbody> <tr> <td><math>\Phi \leq 0.2</math></td> <td>Accept no dense</td> </tr> <tr> <td><math>0.2 &lt; D \leq 0.4</math></td> <td>5</td> </tr> <tr> <td><math>0.4 &lt; D \leq 0.5</math></td> <td>2</td> </tr> <tr> <td><math>0.5 &lt; D</math></td> <td>0</td> </tr> </tbody> </table>  	SIZE (mm)	Acceptable Q' ty	$\Phi \leq 0.2$	Accept no dense	$0.2 < D \leq 0.4$	5	$0.4 < D \leq 0.5$	2	$0.5 < D$	0	2.5
SIZE (mm)	Acceptable Q' ty												
$\Phi \leq 0.2$	Accept no dense												
$0.2 < D \leq 0.4$	5												
$0.4 < D \leq 0.5$	2												
$0.5 < D$	0												
16	Touch Panel Newton ring	Newton ring dimension $\cong 1/2$ touch panel area and not affect font and line distortion ( $\cong 2.5\%$ ), it is acceptable.	2.5										
17	Touch Panel Linearity	Less than 2.5% is acceptable.	2.5										
18	LCD Ripple	Touch the touch panel, can not see the LCD ripple. Pen: R 1.0mm silicon rubber. Operation Force: 80g	2.5										
19	General appearance	19.1 Pin type must match type in specification sheet. 19.2 LCD pin loose or missing pins. 19.3 Product packaging must the same as specified on packaging specification sheet. 19.4 Product dimension and structure must conform to product specification sheet.	0.65 0.65 0.65 0.65										

## 12. Packing method

-----TBD