

SPECIFICATIONS FOR LIQUID CRYSTAL DISPLAY MODULE

MODEL NO.: COG13232C018 DATE:2009-04-27

Approved	Checked	Department
JXJ	JXJ	LWJ

CUSTOMER:
MODEL NO.:

DATE:

Approved :	
REJECT:	



Data:2009-04-27			TECHNICAL SPECIFICATION
LCM		COG13232C018	Page 1 of 15

PRODUCT SPECIFICATIONS

- PHYSICAL DATA
- EXTERNAL DIMENSIONS
- INTERFACE PIN CONNECTIONS
- ABSOLUTE MAXIMUM RATINGS
- RECOMMEND LCM CHARACTERISTICS
- OPERATING PRINCIPLES & METHODS
- ELECTRO-OPTICAL CHARACTERISTICS
- PART LIST
- RELIABILITY
- QUALITY GUARANTEE
- INSPECTION CRITERIA
- PRECAUTIONS FOR USING LCD MODULES
- USING LCD MODULES
- PACKAGE

■ PHYSICAL DATA

Item	Contents	Unit
LCD type	FSTN , TRANSMISSIVE, positive	---
LCD duty	1/32	---
LCD bias	1/7	---
Viewing direction	6	o'clock
Module size (W×H×T)	33.0 ×15.0/36.1 ×1.75	mm
Viewing area (W×H)	29.02 ×7.02	mm
Number of dots	132 ×32	dots
Dot size (W×H)	0.20 × 0.20	mm
Dot pitch (W×H)	0.22 × 0.22	mm

深圳市科飞研科技有限公司



EXTERNAL DIMENSIONS

板次	描述	日期
#A0	首次发行	2008/05/15

PIN	Configuration	PIN	Configuration
1	/CS1	15	NC
2	/RES	16	NC
3	A0	17	NC
4	D6	18	VLCD
5	D7	19	NC
6	VDD	20	NC
7	VSS	21	NC
8	NC	22	NC
9	NC	23	NC
10	C1-	24	NC
11	C1+	25	NC
12	C2+	26	NC
13	C2-	27	NC
14	NC	28	NC

C1与C2值一样, 范围在474-105之间
 C3的取值范围是104-474
 R一般NC, 最好留有位置, 以备调整

- 1.LCM NO:
 1.DISPLAY TYPE: FSTN,TRANSFLECTIVE/POSITIVE.
 2.OPERATING: 8.8V
 3.OPERATING TEMPERATURE: -10°C~+60°C
 4.STORAGE TEMPERATURE: -20°C~+70°C
 5.DRIVE MODE: 1/32DUTY,1/8BIAS
 6.VIEWING DIRECTION: 6:00
 7.JUMARKED TOLERANCE: 0.3mm
 9.LCD DRIVE IC: 502B

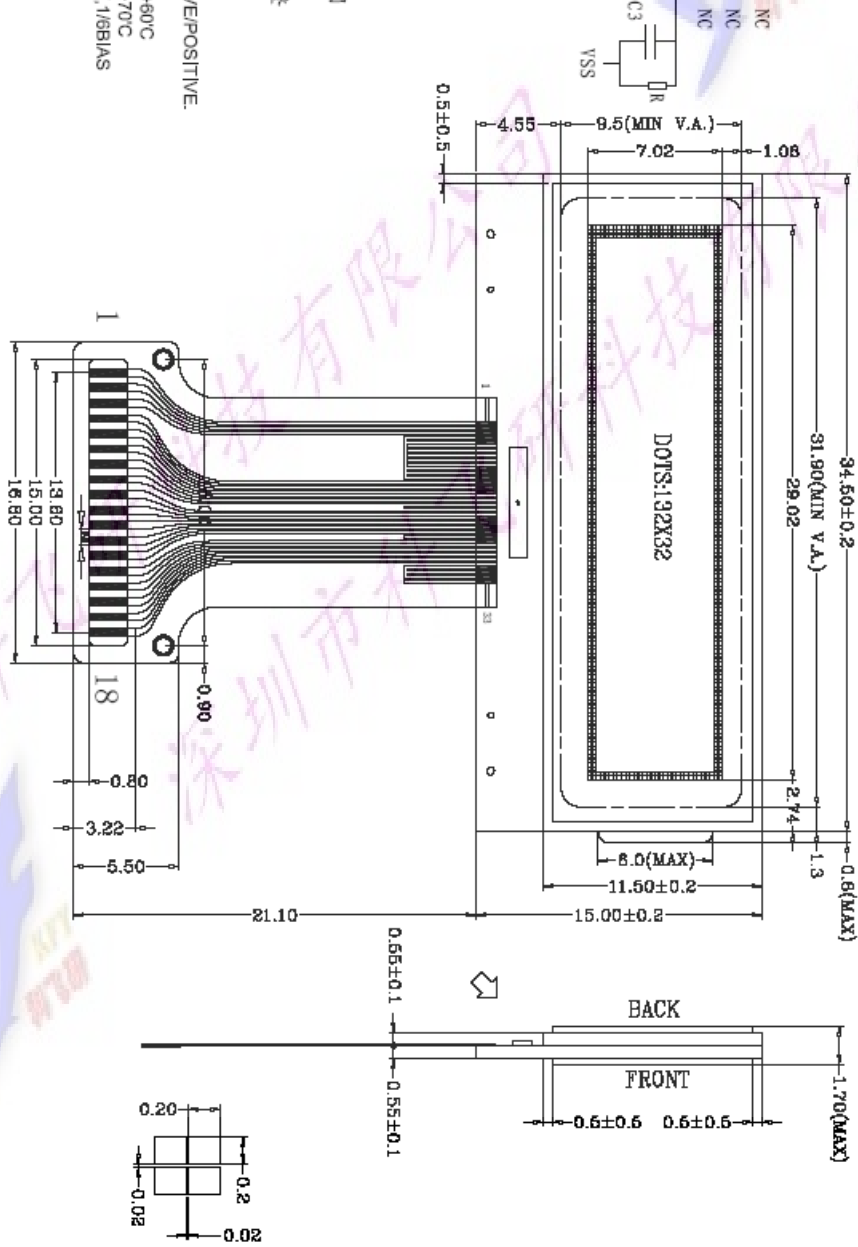

备注

项目名称		LCM图	
型号			
页序: 1/1	版本: #A0	单位: mm	比例: 1:1
制图:	审核:	批准:	日期: 2008/05/15

■ Pin:

PIN	Configuration	PIN	Configuration
1	/CS1	15	NC
2	/RES	16	NC
3	A0	17	NC
4	D6	18	VLCD
5	D7	19	
6	VDD	20	
7	VSS	21	
8	NC	22	
9	NC	23	
10	C1-	24	
11	C1+	25	
12	C2+	26	
13	C2-	27	
14	NC	28	

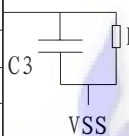

C1与C2值一样，范围在474-105之间

C3的取值范围是104-474

R一般NC，最好留有位置，以备调整

■ ABSOLUTE MAXIMUM RATINGS (Ta = 25°C)

Parameter	Symbol	Min.	Max.	Unit
Supply voltage	VDD	-0.3	3.0	V
Supply voltage for LCD	VLCD(V0-VSS)	-0.3	8.8	V
Input voltage	VIN	-0.3	VDD + 0.3	V
Operating temperature	TOP	-10	60	°C
Storage temperature	TST	-20	70	°C

■ ELECTRICAL CHARACTERISTICS

◆ DC Characteristics

Parameter	Symbol	Condition	Min	Typ	Max	Unit
Supply voltage for LCM	VDD	---	2.7	3.0	3.6	V
Supply current for LCM	IDD1	VDD=3.3V,		0.6		mA
Supply current for LCM	IDD2					
Input voltage 'H' level	VIH	---	0.8VDD	---	VDD	V
Input voltage 'L' level	VIL	---	VSS	---	0.2VDD	V

Note : AC Characteristics Please refer to UC1701 data sheet.

LCM: LCD Module

■ OPERATING PRINCIPLES & METHODS

Note : Please refer to UC1701 data sheet.

◆ Absolute Maximum Ratings

parameter	Symbol	Min.	Max.	Unit
Drive IC Supply voltage	V+	-0.5	3.0	V
Drive IC Enable voltage	E	(V+) - 0.5	(V+) + 0.5	V
Operating temperature	T _O	-20	+70	°C
Storage temperature	T _s	-40	+80	°C

* Note:

1. Instrument: TOPCON Luminance Colorimeter BM-7
2. Measuring field: 2°
3. Measuring distance: 500mm
4. Environment: Dark room, 25°C, 60%RH

■ ELECTRO-OPTICAL CHARACTERISTICS (V_{OP} = 5.5V, T_a = 25°C)

Item	Symbol	Condition	Min	Typ	Max	Unit	Remarks	Note
Operating Voltage	V _{op}	T _a = -20°C	-	-	-	V	---	1
		T _a = 25°C	-	3.0	-		---	1
		T _a = 70°C	-	-	-		---	1
Reponse time	Tr	T _a = 25°C	---	143	---	ms	---	1
	Tf	T _a = 25°C	---	129	---	ms	---	1
Contrast	θ	T _a = 25°C	---	8.1	---	---	---	2
		Cr ≥ 2	36	---	---	deg	∅ = 90°	3
44	---		---	deg	∅ = 270°	3		
40	---		---	deg	∅ = 0°	3		
40	---		---	deg	∅ = 180°	3		

Note1: Definition of response time.

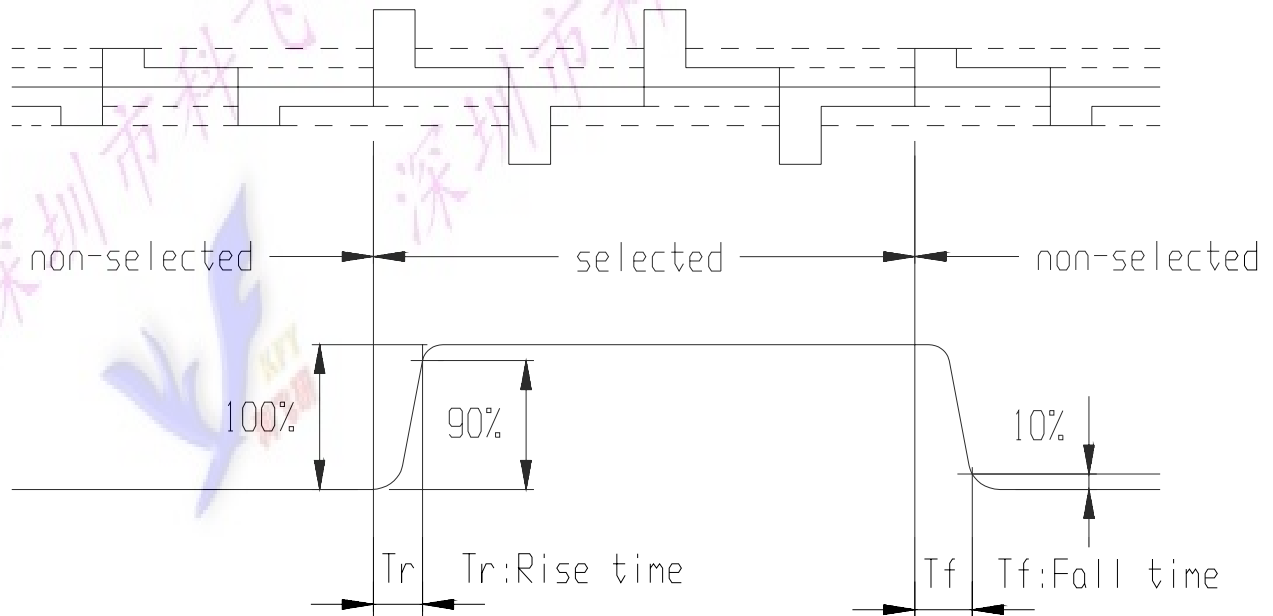

Note2: Definition of contrast ratio 'Cr' .

Note3: Definition of viewing angle range 'θ'.

$$Cr = \frac{\text{Brightness of non-selected segment}(B2)}{\text{Brightness of selected segment}(B1)}$$

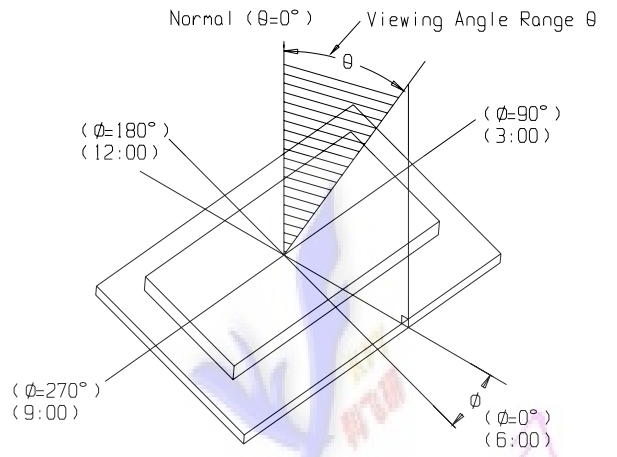
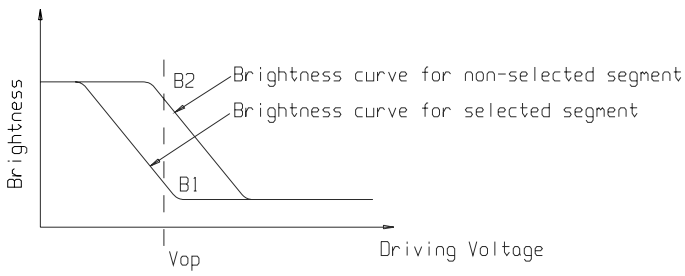

■ PART LIST

Part Name	Description	Quantity
IC	UC1701	1
LCD		1
FPC connector		1
PCB		
Plastic Holder		

■ RELIABILITY

◆ Content of Reliability Test

Environmental Test				
No.	Test Item	Content of Test	Test Condition	Applicable Standard
1	High temperature storage	Endurance test applying the high storage temperature for a long time.	70 °C 200 hrs	-----
2	Low temperature storage	Endurance test applying the low storage temperature for a long time.	-30 °C 200 hrs	-----
3	High temperature operation	Endurance test applying the electric stress (Voltage & Current) and the thermal stress to the element for a long time.	60 °C 200 hrs	-----
4	Low temperature operation	Endurance test applying the electric stress under low temperature for a long time.	-10 °C 200 hrs	-----
5	High temperature / Humidity storage	Endurance test applying the high temperature and high humidity storage for a long time.	60 °C , 90 %RH 96 hrs	MIL-202E-103B JIS-C5023
6	High temperature / Humidity operation	Endurance test applying the electric stress (Voltage & Current) and temperature / humidity stress to the element for a long time.	50 °C , 90 %RH 96 hrs	MIL-202E-103B JIS-C5023
7	Temperature cycle	Endurance test applying the low and high temperature cycle. $\begin{array}{ccccc} -10^{\circ}\text{C} & \rightleftharpoons & 25^{\circ}\text{C} & \rightleftharpoons & 60^{\circ}\text{C} \\ 30\text{min} & \leftarrow & 5\text{min.} & \leftarrow & 30\text{min} \\ & & \text{1 cycle} & & \end{array}$	-10°C / 70°C 10 cycles	
Mechanical Test				
8	Vibration test	Endurance test applying the vibration during transportation and using.	10~22Hz → 1.5mmp-p 22~500Hz → 1.5G Total 0.5hrs	MIL-202E-201A JIS-C5025 JIS-C7022-A-10
9	Shock test	Constructional and mechanical endurance test applying the shock during transportation.	50G Half sign wave 11 msedc 3 times of each direction	MIL-202E-213B
10	Atmospheric pressure test	Endurance test applying the atmospheric pressure during transportation by air.	115 mbar 40 hrs	MIL-202E-105C
Others				
11	Static electricity test	Endurance test applying the electric stress to the terminal.	VS=800V , RS=1.5 kΩ CS=100 pF 1 time	MIL-883B-3015.1

*** Supply voltage for logic system = VDD. Supply voltage for LCD system = Operating voltage at 25°C

◆ Failure Judgement Criterion

Criterion Item	Test Item No.											Failure Judgment Criterion	
	1	2	3	4	5	6	7	8	9	10	11		
Basic specification													Out of the Basic Specification
Electrical characteristic													Out of the DC and AC Characterstic
Mechanical characterstic													Out of the Mechanical Specification Color change : Out of Limit Apperance Specification
Optical characterstic													Out of the Apperance Standard

■ QUALITY GUARANTEE

◆ Acceptable Quality Level

Each lot should satisfy the quality level defined as follows. - AQL

Partition	AQL	Definition
A: Major	0.4%	Functional defective as product
B: Minor	1.5%	Satisfy all functions as product but not satisfy cosmetic standard

◆ Definition of 'LOT'

One lot means the delivery quantity to customer at one time.

◆ Conditions of Cosmetic Inspection

● Environmental condition

The inspection should be performed at the 1m of height from the LCD module under 2 pieces of 40W white fluorescent lamps (Normal temperature 20~25°C and normal humidity 60±15%RH).

● Inspection method

The visual check should be performed vertically at more than 30cm distance from the LCD panel.

● Driving voltage

The V_0 value which the most optimal contrast can be obtained near the specified V_0 in the specification. (Within ±0.5V of the typical value at 25°C.).

■ INSPECTION CRITERIA

◆ Module Cosmetic Criteria

No.	Item	Judgement Criterion	Partition
1	Difference in Spec.	None allowed	Major
2	Pattern peeling	No substrate pattern peeling and floating	Major
3	Soldering defects	No soldering missing No soldering bridge No cold soldering	Major Major Minor
4	Resist flaw on substrate	Invisible copper foil (Ø0.5mm or more) on substrate pattern	Minor
5	Accretion of metallic Foreign matter	No soldering dust No accretion of metallic foreign matters (Not exceed Ø0.2mm)	Minor Minor
6	Stain	No stain to spoil cosmetic badly	Minor
7	Plate discoloring	No plate fading, rusting and discoloring	Minor
8	Solder amount	a. Soldering side of PCB Solder to form a 'Filet' all around the lead. Solder should not hide the lead form perfectly. (too much)	Minor
	1. Lead parts	b. Components side (In case of 'Through Hole PCB') Solder to reach the Components side of PCB.	
	2. Flat packages	Either 'toe' (A) or 'heel' (B) of the lead to be covered by 'Filet'. Lead form to be assume over solder.	
	3. Chips	$(3/2) H \geq h \geq (1/2) H$	Minor

◆ Screen Cosmetic Criteria (Non-Operating)

No.	Defect	Judgement Criterion	Partition										
1	Spots	In accordance with <i>Screen Cosmetic Criteria (Operating) No.1.</i>	Minor										
2	Lines	In accordance with <i>Screen Cosmetic Criteria (Operating) No.2.</i>	Minor										
3	Bubbles in polarizer	<table border="1"> <thead> <tr> <th>Size : d mm</th> <th>Acceptable Qty in active area</th> </tr> </thead> <tbody> <tr> <td>d ≤ 0.3</td> <td>Disregard</td> </tr> <tr> <td>0.3 < d ≤ 1.0</td> <td>3</td> </tr> <tr> <td>1.0 < d ≤ 1.5</td> <td>1</td> </tr> <tr> <td>1.5 < d</td> <td>0</td> </tr> </tbody> </table>	Size : d mm	Acceptable Qty in active area	d ≤ 0.3	Disregard	0.3 < d ≤ 1.0	3	1.0 < d ≤ 1.5	1	1.5 < d	0	Minor
Size : d mm	Acceptable Qty in active area												
d ≤ 0.3	Disregard												
0.3 < d ≤ 1.0	3												
1.0 < d ≤ 1.5	1												
1.5 < d	0												
4	Scratch	In accordance with spots and lines operating cosmetic criteria. When the light reflects on the panel surface, the scratches are not to be remarkable.	Minor										
5	Allowable density	Above defects should be separated more than 30mm each other.	Minor										
6	Coloration	Not to be noticeable coloration in the viewing area of the LCD panels. Back-lit type should be judged with back-lit on state only.	Minor										
7	Contamination	Not to be noticeable.	Minor										

◆ Screen Cosmetic Criteria (Operating)

No.	Defect	Judgement Criterion	Partition																				
1	Spots	<p>A) Clear</p> <table border="1"> <thead> <tr> <th>Size : d mm</th> <th>Acceptable Qty in active area</th> </tr> </thead> <tbody> <tr> <td>d ≤ 0.1</td> <td>Disregard</td> </tr> <tr> <td>0.1 < d ≤ 0.2</td> <td>6</td> </tr> <tr> <td>0.2 < d ≤ 0.3</td> <td>2</td> </tr> <tr> <td>0.3 < d</td> <td>0</td> </tr> </tbody> </table> <p>Note : Including pin holes and defective dots which must be within one pixel size.</p> <p>B) Unclear</p> <table border="1"> <thead> <tr> <th>Size : d mm</th> <th>Acceptable Qty in active area</th> </tr> </thead> <tbody> <tr> <td>d ≤ 0.2</td> <td>Disregard</td> </tr> <tr> <td>0.2 < d ≤ 0.5</td> <td>6</td> </tr> <tr> <td>0.5 < d ≤ 0.7</td> <td>2</td> </tr> <tr> <td>0.7 < d</td> <td>0</td> </tr> </tbody> </table>	Size : d mm	Acceptable Qty in active area	d ≤ 0.1	Disregard	0.1 < d ≤ 0.2	6	0.2 < d ≤ 0.3	2	0.3 < d	0	Size : d mm	Acceptable Qty in active area	d ≤ 0.2	Disregard	0.2 < d ≤ 0.5	6	0.5 < d ≤ 0.7	2	0.7 < d	0	Minor
Size : d mm	Acceptable Qty in active area																						
d ≤ 0.1	Disregard																						
0.1 < d ≤ 0.2	6																						
0.2 < d ≤ 0.3	2																						
0.3 < d	0																						
Size : d mm	Acceptable Qty in active area																						
d ≤ 0.2	Disregard																						
0.2 < d ≤ 0.5	6																						
0.5 < d ≤ 0.7	2																						
0.7 < d	0																						
2	Lines	<p>A) Clear</p> <p>Note : () - Acceptable Qty in active area L - Length (mm) W - Width (mm) ∞ - Disregard</p> <p>B) Unclear</p>	Minor																				

'Clear' = The shade and size are not changed by Vo. ; 'Unclear' = The shade and size are changed by Vo.

◆ Screen Cosmetic Criteria (Operating) (Continued)

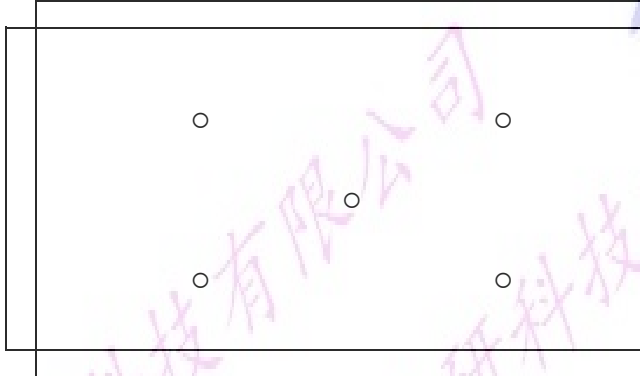
No.	Defect	Judgement Criterion	Partition
3	Rubbing line	Not to be noticeable.	
4	Allowable density	Above defects should be separated more than 10mm each other.	Minor
5	Rainbow	Not to be noticeable.	Minor
6	Dot size	To be 95% ~ 105% of the dot size (Typ.) in drawing. Partial defects of each dot (ex. pin-hole) should be treated as 'spot'. (see <i>Screen Cosmetic Criteria (Operating) No.1</i>)	Minor
7	Uneven brightness (only back-lit type module)	Uneven brightness must be $B_{MAX} / B_{MIN} \leq 2$ - B_{MAX} : Max. value by measure in 5 points - B_{MIN} : Min. value by measure in 5 points Divide active area into 4 vertically and horizontally. Measure 5 points shown in the following figure.  ○ : Measuring points	Minor

Note :

- (1) Size : $d = (\text{long length} + \text{short length}) / 2$
- (2) The limit samples for each item have priority.
- (3) Complexed defects are defined item by item, but if the number of defects are defined in above table, the total number should not exceed 10.
- (4) In case of 'concentration', even the spots or the lines of 'disregarded' size should not allowed. Following three situations should be treated as 'concentration'.
 - 7 or over defects in circle of $\varnothing 5\text{mm}$.
 - 10 or over defects in circle of $\varnothing 10\text{mm}$.
 - 20 or over defects in circle of $\varnothing 20\text{mm}$.

■ PRECAUTIONS FOR USING LCD MODULES

◆ Handling Precautions

- (1) The display panel is made of glass. Do not subject it to a mechanical shock by dropping it or impact.
- (2) If the display panel is damaged and the liquid crystal substance leaks out, be sure not to get any in your mouth. If the substance contacts your skin or clothes, wash it off using soap and water.
- (3) Do not apply excessive force to the display surface or the adjoining areas since this may cause the color tone to vary.
- (4) The polarizer covering the display surface of the LCD module is soft and easily scratched. Handle this polarizer carefully.
- (5) If the display surface becomes contaminated, breathe on the surface and gently wipe it with a soft dry cloth. If it is heavily contaminated, moisten cloth with one of the following solvents :
 - Isopropyl alcohol
 - Ethyl alcohol
- (6) Solvents other than those above-mentioned may damage the polarizer. Especially, do not use the following.
 - Water
 - Ketone
 - Aromatic solvents
- (7) Exercise care to minimize corrosion of the electrode. Corrosion of the electrodes is accelerated by water droplets, moisture condensation or a current flow in a high-humidity environment.
- (8) Install the LCD Module by using the mounting holes. When mounting the LCD module make sure it is free of twisting, warping and distortion. In particular, do not forcibly pull or bend the I/O cable or the backlight cable.
- (9) Do not attempt to disassemble or process the LCD module.
- (10) NC terminal should be open. Do not connect anything.
- (11) If the logic circuit power is off, do not apply the input signals.
- (12) To prevent destruction of the elements by static electricity, be careful to maintain an optimum work environment.
 - Be sure to ground the body when handling the LCD modules.
 - Tools required for assembling, such as soldering irons, must be properly grounded.
 - To reduce the amount of static electricity generated, do not conduct assembling and other work under dry conditions.
 - The LCD module is coated with a film to protect the display surface. Exercise care when peeling off this protective film since static electricity may be generated.

◆ Storage Precautions

When storing the LCD modules, avoid exposure to direct sunlight or to the light of fluorescent lamps. Keep the modules in bags (avoid high temperature / high humidity and low temperatures below 0°C). Whenever possible, the LCD modules should be stored in the same conditions in which they were shipped from our company.

◆ Others

Liquid crystals solidify under low temperature (below the storage temperature range) leading to defective orientation or the generation of air bubbles (black or white). Air bubbles may also be generated if the module is subject to a low temperature.

If the LCD modules have been operating for a long time showing the same display patterns, the display patterns may remain on the screen as ghost images and a slight contrast irregularity may also appear. A normal operating status can be regained by suspending use for some time. It should be noted that this phenomenon does not adversely affect performance reliability.

To minimize the performance degradation of the LCD modules resulting from destruction caused by static electricity etc., exercise care to avoid holding the following sections when handling the modules.

- Exposed area of the printed circuit board.
- Terminal electrode sections.

■ USING LCD MODULES

◆ Liquid Crystal Display Modules

LCD is composed of glass and polarizer. Pay attention to the following items when handling.

- (1) Please keep the temperature within specified range for use and storage. Polarization degradation, bubble generation or polarizer peel-off may occur with high temperature and high humidity.
- (2) Do not touch, push or rub the exposed polarizers with anything harder than an HB pencil lead (glass, tweezers, etc.).
- (3) N-hexane is recommended for cleaning the adhesives used to attach front/rear polarizers and reflectors made of organic substances which will be damaged by chemicals such as acetone, toluene, ethanol and isopropylalcohol.
- (4) When the display surface becomes dusty, wipe gently with absorbent cotton or other soft material like chamois soaked in petroleum benzin. Do not scrub hard to avoid damaging the display surface.
- (5) Wipe off saliva or water drops immediately, contact with water over a long period of time may cause deformation or color fading.
- (6) Avoid contacting oil and fats.
- (7) Condensation on the surface and contact with terminals due to cold will damage, stain or dirty the polarizers. After products are tested at low temperature they must be warmed up in a container before coming in contact with room temperature air.
- (8) Do not put or attach anything on the display area to avoid leaving marks on.
- (9) Do not touch the display with bare hands. This will stain the display area and degradate insulation between terminals (some cosmetics are determined to the polarizers).
- (10) As glass is fragile. It tends to become or chipped during handling especially on the edges. Please avoid dropping or jarring.

◆ Installing LCD Modules

The hole in the printed circuit board is used to fix LCM as shown in the picture below. Attend to the following items when installing the LCM.

- (1) Cover the surface with a transparent protective plate to protect the polarizer and LCD cell.

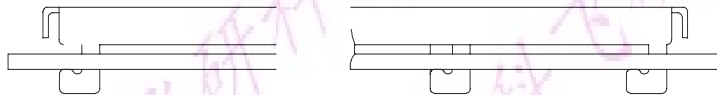

- (2) When assembling the LCM into other equipment, the spacer to the bit between the LCM and the fitting plate should have enough height to avoid causing stress to the module surface, refer to the individual specifications for measurements. The measurement tolerance should be $\pm 0.1\text{mm}$.

◆ Precaution for Handling LCD Modules

Since LCM has been assembled and adjusted with a high degree of precision, avoid applying excessive shocks to the module or making any alterations or modifications to it.

- (1) Do not alter, modify or change the the shape of the tab on the metal frame.
- (2) Do not make extra holes on the printed circuit board, modify its shape or change the positions of components to be attached.
- (3) Do not damage or modify the pattern writing on the printed circuit board.
- (4) Absolutely do not modify the zebra rubber strip (conductive rubber) or heat seal connector.
- (5) Except for soldering the interface, do not make any alterations or modifications with a soldering iron.
- (6) Do not drop, bend or twist LCM.

◆ Electro-Static Discharge Control

Since this module uses a CMOS LSI, the same careful attention should be paid to electrostatic discharge as for an ordinary CMOS IC.

- (1) Make certain that you are grounded when handing LCM.
- (2) Before remove LCM from its packing case or incorporating it into a set, be sure the module and your body have the same electric potential.
- (3) When soldering the terminal of LCM, make certain the AC power source for the soldering iron does not leak.
- (4) When using an electric screwdriver to attach LCM, the screwdriver should be of ground potential to minimize as much as possible any transmission of electromagnetic waves produced sparks coming from the commutator of the motor.
- (5) As far as possible make the electric potential of your work clothes and that of the work bench the ground potential.
- (6) To reduce the generation of static electricity be careful that the air in the work is not too dried. A relative humidity of 50%-60% is recommended.

◆ Precaution for soldering to the LCM

- (1) Observe the following when soldering lead wire, connector cable and etc. to the LCM.
 - Soldering iron temperature : $280^{\circ}\text{C} \pm 10^{\circ}\text{C}$.
 - Soldering time : 3-4 sec.
 - Solder : eutectic solder.

If soldering flux is used, be sure to remove any remaining flux after finishing to soldering operation. (This does not apply in the case of a non-halogen type of flux.) It is recommended that you protect the LCD surface with a cover during soldering to prevent any damage due to flux spatters.

(2) When soldering the electroluminescent panel and PC board, the panel and board should not be detached more than three times. This maximum number is determined by the temperature and time conditions mentioned above, though there may be some variance depending on the temperature of the soldering iron.

(3) When remove the electoluminescent panel from the PC board, be sure the solder has completely melted, the soldered pad on the PC board could be damaged.

◆ Precautions for Operation

- (1) Viewing angle varies with the change of liquid crystal driving voltage (V_0). Adjust V_0 to show the best contrast.
- (2) Driving the LCD in the voltage above the limit shortens its life.
- (3) Response time is greatly delayed at temperature below the operating temperature range. However, this does not mean the LCD will be out of the order. It will recover when it returns to the specified temperature range.
- (4) If the display area is pushed hard during operation, the display will become abnormal. However, it will return to normal if it is turned off and then back on.
- (5) Condensation on terminals can cause an electrochemical reaction disrupting the terminal circuit. Therefore, it must be used under the relative condition of 40°C , 50% RH.
- (6) When turning the power on, input each signal after the positive/negative voltage becomes stable.

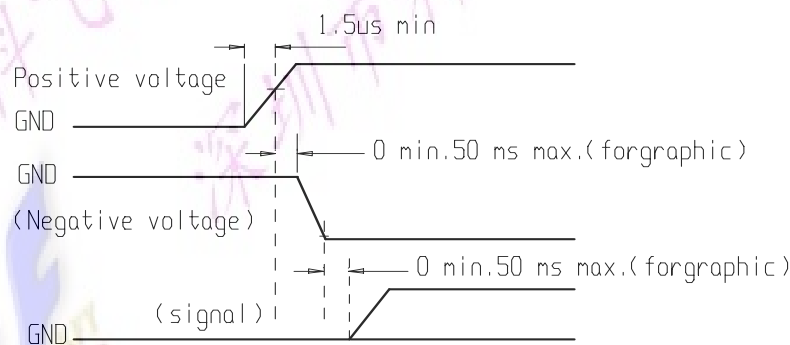

◆ Storage

When storing LCDs as spares for some years, the following precaution are necessary.

- (1) Store them in a sealed polyethylene bag. If properly sealed, there is no need for dessicant.
- (2) Store them in a dark place. Do not expose to sunlight or fluorescent light, keep the temperature between 0°C and 35°C .
- (3) The polarizer surface should not come in contact with any other objects. (We advise you to store them in the container in which they were shipped.)

◆ Safety

(1) It is recommended to crush damaged or unnecessary LCDs into pieces and wash them off with solvents such as acetone and ethanol, which should later be burned.

(2) If any liquid leaks out of a damaged glass cell and comes in contact with the hands, wash off thoroughly with soap and water.

◆ **Limited Warranty**

Unless agreed between AV-DISPLAY and customer, AV-DISPLAY will replace or repair any of its LCD modules which are found to be functionally defective when inspected in accordance with AV-DISPLAY LCD acceptance standards (copies available upon request) for a period of one year from date of shipments. Cosmetic/visual defects must be returned to AV-DISPLAY within 90 days of shipment. Confirmation of such date shall be based on freight documents. The warranty liability of AV-DISPLAY limited to repair and/or replacement on the terms set forth above. AV-DISPLAY will not be responsible for any subsequent or consequential events.

◆ **Return LCM under warranty**

No warranty can be granted if the precautions stated above have been disregarded. The typical examples of violations are :

- Broken LCD glass.
- PCB eyelet's damaged or modified.
- PCB conductors damaged.
- Circuit modified in any way, including addition of components.
- PCB tampered with by grinding, engraving or painting varnish.
- soldering to or modifying the bezel in any manner.

Module repairs will be invoiced to the customer upon mutual agreement. Modules must be returned with sufficient description of the failures or defects. Any connectors or cable installed by the customer must be removed completely without damaging the PCB eyelet's, conductors and terminals.

■ **PACKAGE**